

PROJECT NAME

# HELIOS

BASED ON

Pro Co® RAT Distortion

EFFECT TYPE

Distortion

BUILD DIFFICULTY

■■■■■ Easy

DOCUMENT VERSION

1.0.1 (2024-08-08)

**aiON**  
DIY GUITAR EFFECTS

## PROJECT SUMMARY

A distortion pedal with a very distinctive and tight mid-to-high-gain character that made it a staple in the rigs of 1980s hard rock bands.



### IMPORTANT NOTE

This documentation is for the **kit** version of the project. If you purchased the PCB by itself, please use the [PCB-only version](#) of the documentation instead. The circuit is the same, but the instructions are completely different due to the specialized parts and assembly methods used in the kit.

# TABLE OF CONTENTS

---

- 1 Project Overview
- 2 Table of Contents
- 3 Introduction
- 4 Packing List
- 5 Packing List (Cont.)
- 6 Tools Needed
- 7 Component Identification
- 8 Hardware Identification
- 9 PCB Assembly Overview
- 10 Resistors
- 11 Diodes
- 12 Socket & IC
- 13 Transistors
- 14 Capacitors (Non-Polarized)
- 15 Wire Headers
- 16 Capacitors (Polarized)
- 17 Footswitch PCB
- 18 Input/Output PCB
- 19 Enclosure Layout: Panel Mounts
- 20 Enclosure Layout: Panel Mounts (Cont.)
- 21 Enclosure Layout: Main & Footswitch PCBs
- 22 Enclosure Layout: Input/Output PCB
- 23 Final Testing & Assembly
- 24 Schematic
- 25 Full Parts List
- 26 Troubleshooting Information
- 27 Support & Resale Terms
- 28 Legal Information & Document Revisions

# INTRODUCTION

---

If this is your first pedal, welcome to the hobby and thank you for choosing Aion FX. You've just joined a community of over 100,000 people around the world with a passion for building homemade noise machines using obsolete electronics technology, and we're glad to have you!

If you've done this before, it's great to see you again and we're confident you'll find this build experience an enjoyable one.

Aion FX kits are designed to empower anyone to build a high-quality pedal, no matter the skill level. The pedalbuilding hobby has traditionally had a steep learning curve, but don't be overwhelmed—we've done all the hard work for you. All you need to do is follow these instructions and you'll be on your way to transforming your tone.

There are a few things to go over before you get started.

- **You're going to have to get your hands dirty**—there's no way around it. Nothing here comes preassembled, and you'll have to learn the skills to put it all together. This document will walk you through everything you need, but be prepared to learn a few things along the way.
- **This will take time.** Plan on about two hours start to finish. It may take even longer if it's your first time building. Don't rush it. If you find yourself getting frustrated or overwhelmed, take a break and come back in a couple of hours or the next day.
- **No direct technical support is offered.** There are several DIY forums and Facebook groups with thousands of members who enjoy troubleshooting and teaching. But please be sensitive to the fact that the staff at Aion FX is minimal, and every minute spent helping individuals in private is time that can't be spent on new project development.
- **There is no implied guarantee of a final product.** Aion FX provides the ingredients and the recipe, but you are responsible for putting everything together to make it work. We've tried to make the process as clear and accessible as possible, but it must be expressly stated that purchasing the kit is not a guarantee that you will end up with a working pedal.

It's recommended to read through all of the instructions before you start, particularly if you've never built a pedal before. If you familiarize yourself with the entire process ahead of time and you know what the goal looks like, each step will make more sense.

Now, on to the fun stuff!

# PACKING LIST

---

This is a list of all the parts that are included with the kit, grouped by value. For a list of all the parts based on their PCB part numbers, please see page 25.

If you find that any parts are missing or damaged, please fill out the [Missing Parts](#) form.

## Film Capacitors

NAME	QTY
1n (0.001)	1
3n3 (0.0033)	1
22n (0.022)	2
1uF	1

## Electrolytic Capacitors

NAME	QTY
2.2uF	1
4.7uF	2
47uF	1
100uF	1

## MLCC Capacitors

NAME	QTY
100pF (marked "101")	1
100n (marked "104")	1

## Diodes

NAME	QTY
1N5817	1
1N914	6
LED, red	2

## Resistors

NAME	QTY
47R	2
560R	1
1k	2
1k5	1
10k	2
100k	2
1M	2
2M2	1

## ICs

NAME	QTY
OP07	1
8-pin socket	1

## Transistors

NAME	QTY
PN4303	1

## PACKING LIST (CONT.)

---

### Potentiometers

NAME	QTY
1k $\Omega$	1
100k $\Omega$	3
Dust cover	4
Knob	4
Mounting nut, potentiometer, 0.44"	4
Lock washer, potentiometer, 0.5"	4
Outer washer, potentiometer, 0.475"	4

### Other

NAME	QTY
LED bezel	1
LED, blue	1
9V battery snap	1
DC jack	1
Input/output jack	2
Mounting nut, jack, 0.54"	4
Outer washer, jack, 0.6"	2
Lock washer, jack, 0.5" (thin)	2
Enclosure	1
Enclosure screws	4
PCB, main circuit	1
PCB, footswitch	1
PCB, input/output/DC	1

### Switches

NAME	QTY
Toggle switch, SPDT on-off-on	1
Mounting nut, toggle switch, 0.36"	1
Lock washer, toggle switch, 0.4"	1
Dress nut, toggle switch, 0.375"	1
Stomp switch, 3PDT	1
Mounting nut, stomp switch, 0.6"	2
Lock washer, stomp switch, 0.6"	1
Dress nut, stomp switch, 0.77"	1

### Wiring

NAME	QTY
3-strand wire assembly, 70mm	2
4-strand wire assembly, 108mm	1
3-pin wire assembly header	2
4-pin wire assembly header	1

## TOOLS NEEDED

---

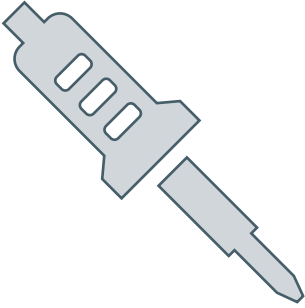

### SOLDERING IRON

Temperature-adjustable is recommended. The optimum soldering temperature is 700-725° F (371-385° C) for leaded solder, or 750° F (400° C) for lead-free.

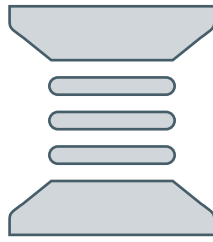

### SOLDER

Preferably 63/37 or 60/40 leaded solder. Lead-free is more difficult to use, so if that's the only type you can get, it's best to watch tutorials that are specific to lead-free solder.

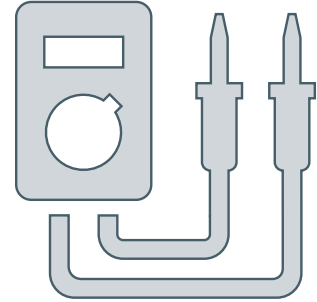

### DIGITAL MULTIMETER (DMM)

Most cheap ones in the \$10-30 range are fine for what we're doing. Make sure it has audible continuity testing (i.e. it beeps at the lowest resistance) and transistor hFE measurement.

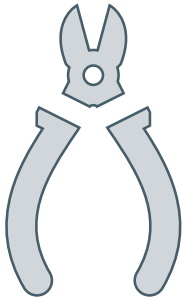

### WIRE SNIPPERS

Also called nippers or wire cutters. The Hakko CHP-170 is the best you can get for less than \$10.

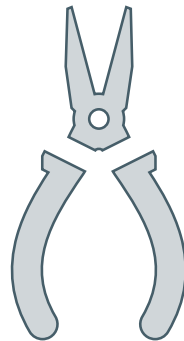

### FLAT-NOSE PLIERS

Many general-purpose uses, but particularly tightening the nuts of pots, switches and jacks. Quicker than changing out sockets on a ratchet.

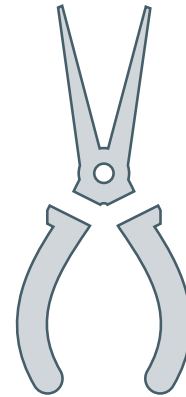

### NEEDLE-NOSE PLIERS

These are used for bending leads on components and other general uses. Use the smaller type with a tip that's approximately 0.05" (1.25mm) wide.

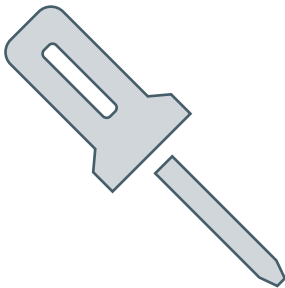

### SCREWDRIVER (PHILLIPS)

Used for the enclosure screws. Get a powered driver if you'll be building a lot of pedals!

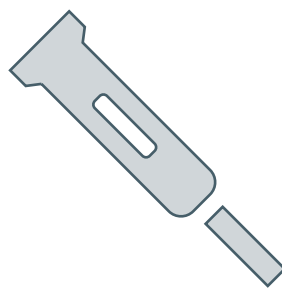

### FLAT SCREWDRIVER (SMALL)

This is used for tightening the set screws on the knobs. The tip should be no more than 0.1" (2.5mm) wide.

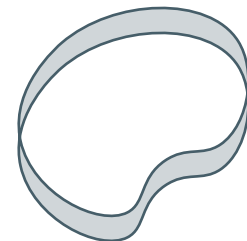

### RUBBER BAND

Yes, a plain old rubber band. This is used to tighten the dress nut to avoid scratching or denting it (which can happen with metal tools).

# COMPONENT IDENTIFICATION

If you've never built a pedal before, you'll need to know what all the components are. These are shown actual size. (Not all of these types of components may be part of this kit.)

## RESISTOR

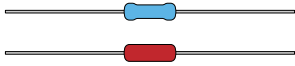

## TRIM POTENTIOMETER

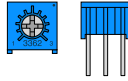

## LED

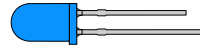

## SILICON DIODE



## GERMANIUM DIODE

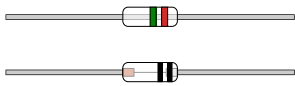

*These are very fragile, so be careful when handling them.*

## RECTIFIER DIODE



## SCHOTTKY DIODE



*Some Schottky diodes also look like this.*

## ZENER DIODE



## FILM CAPACITOR

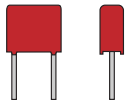

*Not polarized. Color may vary by brand and type.*

## ELECTROLYTIC CAPACITOR



*Polarized. The negative side is marked.*

## MLCC

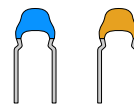

*Not polarized. MLCC stands for "multi-layer ceramic capacitor."*

## TANTALUM CAPACITOR



*Polarized. The positive side is marked.*

## OP-AMP / IC

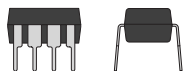

*Charge pumps and delay chips also look like this. They may have more than 8 legs.*

## IC SOCKET

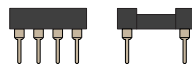

## TRANSISTOR OR JFET

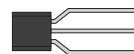

*Some voltage regulators also look like this.*

## SNAP-APART SOCKET



*It's recommended to use a razor blade to separate these cleanly.*

## WIRE ASSEMBLY



## WIRE ASSEMBLY HEADER

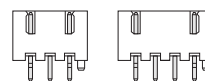

## LED BEZEL





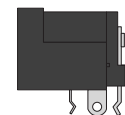

## DC JACK



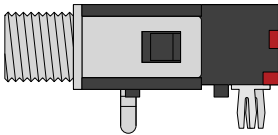
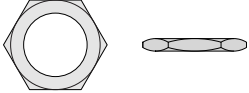
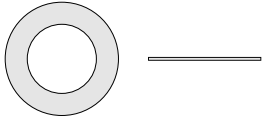
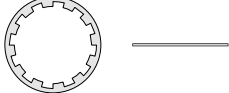

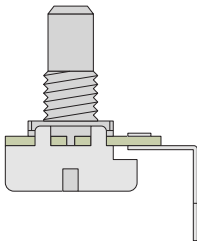
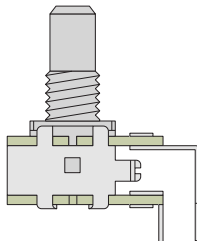

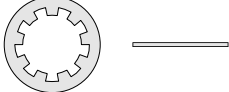
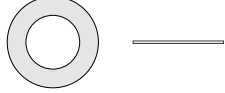
# HARDWARE IDENTIFICATION

The hardware comes unassembled, so you'll need to sort & identify each of the pieces. The diagrams below are actual size, so you can set them against the printed page to identify them if needed.

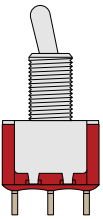
<p><b>I/O JACK</b></p> 	<p><b>MOUNTING NUT</b></p>  <p>DIAMETER: 0.54" / 13.7mm</p>	<p><b>OUTER WASHER</b></p>  <p>DIAMETER: 0.6" / 15.2mm</p>	<p><b>LOCK WASHER</b></p>  <p>DIAMETER: 0.5" / 12.7mm</p>
--	--	--	--

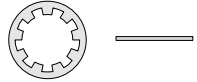
<p><b>POTENTIOMETER (SINGLE)</b></p> 	<p><b>POTENTIOMETER (DUAL)</b></p> 	<p><b>MOUNTING NUT</b></p>  <p>DIAMETER: 0.44" / 11.2mm</p>	<p><b>LOCK WASHER</b></p>  <p>DIAMETER: 0.5" / 12.7mm</p>
		<p><b>OUTER WASHER</b></p>  <p>DIAMETER: 0.475" / 12mm</p>	<p><b>KNOB</b></p> 

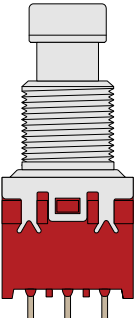
<p><b>TOGGLE SWITCH</b></p> 	<p><b>MOUNTING NUT</b></p>  <p>DIAMETER: 0.36" / 9.1mm</p>	<p><b>DRESS NUT</b></p>  <p>DIAMETER: 0.375" / 9.5mm</p>	<p><b>LOCK WASHER</b></p>  <p>DIAMETER: 0.4" / 10.1mm</p>
---	---	--	--

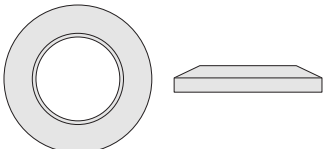
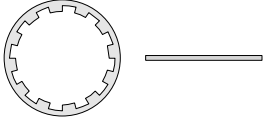
<p><b>FOOTSWITCH</b></p> 	<p><b>MOUNTING NUT</b></p>  <p>DIAMETER: 0.6" / 15.2mm</p>	<p><b>DRESS NUT</b></p>  <p>DIAMETER: 0.77" / 19.6mm</p>	<p><b>LOCK WASHER</b></p>  <p>DIAMETER: 0.6" / 15.2mm</p>
--	---	--	--



# PCB ASSEMBLY OVERVIEW

Now it's time to start building!

Before you begin, separate the PCBs into individual boards and break off the tabs from each using needle-nose or flat-head pliers. You should be left with the three PCBs shown to the right.

The general principle for PCB population is that you want to work in layers from shortest components (i.e. lowest-profile) to tallest so that when the PCB is upside-down, everything is making contact with the work surface and is held in place.

Generally speaking, you should populate the components in this order:

1. Resistors
2. Diodes
3. IC sockets
4. MLCC capacitors
5. Film capacitors
6. Transistors
7. Electrolytic capacitors

Not all of these component types are included in each kit, so skip them if they aren't applicable. Some types of film capacitors are taller than electrolytics, so those can be done last.

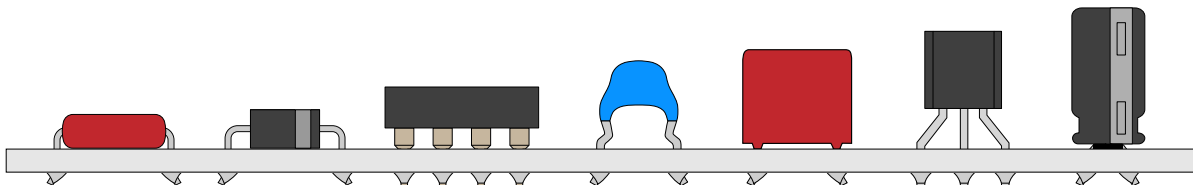
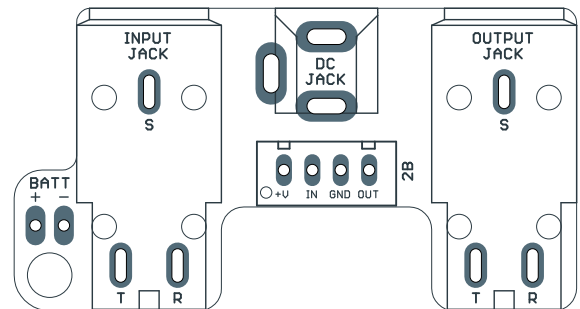
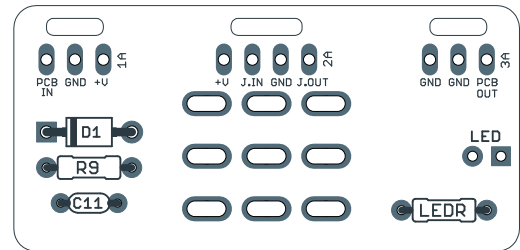
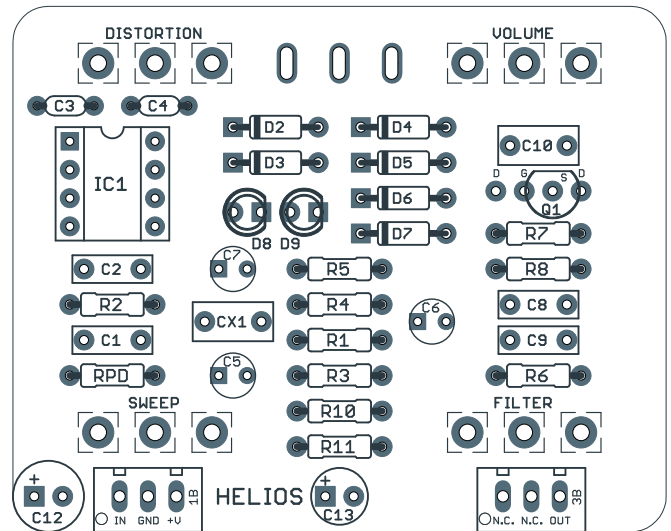

# RESISTORS

PART	VALUE	PART	VALUE
R1	1M	R8	10k
R2	1k	R9	47R
R3	47R	R10	100k
R4	560R	R11	100k
R5	1k	RPD	2M2
R6	1k5	LEDR	10k
R7	1M		

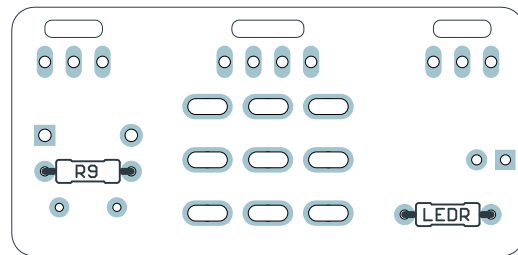
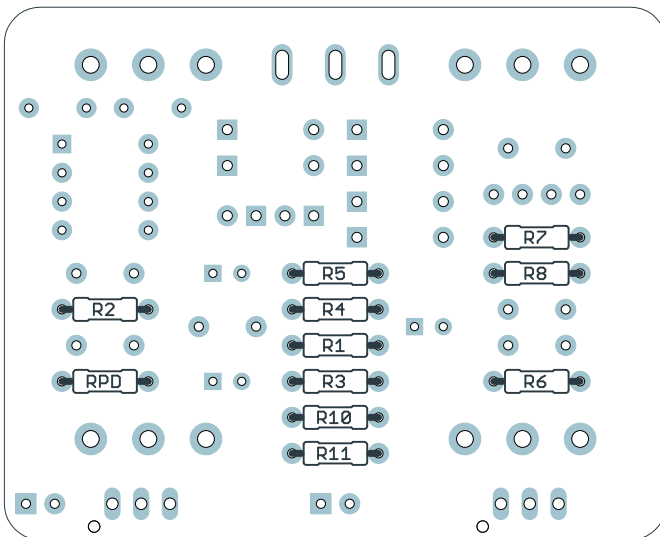

Using the parts list above, populate the resistors by pushing them through the holes and bending the leads outward at an angle to hold them in place. Resistors are not polarized, so they will work in any direction. Turn the board upside-down to keep the components held in place while you solder.

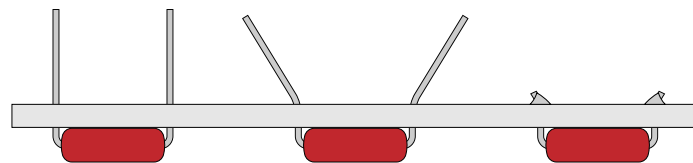

You'll use this same technique for most of the other components as well.

Don't try to do all of the resistors at once. You'll want to stop periodically flip the board and solder everything, then cut the leads using the wire snippers to make room for more. Generally you don't want to do more than 15 to 20 resistors at a time or the bottom of the board will get too crowded.

If this is your first time soldering, watch tutorial videos on YouTube and make sure you get it down before you begin. You don't want to practice or experiment on this board!

# DIODES

PART	VALUE
D1	1N5817
D2	1N914
D3	1N914
D4	1N914
D5	1N914

PART	VALUE
D6	1N914
D7	1N914
D8	LED, red
D9	LED, red

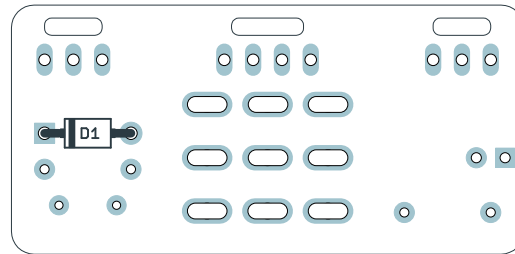
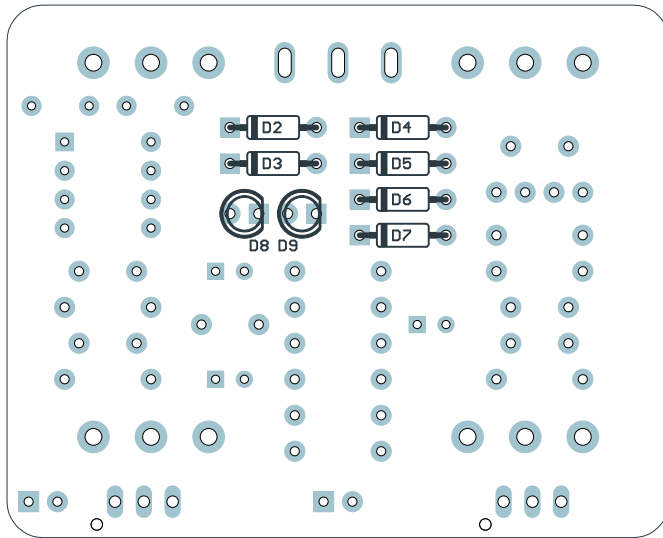

Next, you'll populate the diodes. Diodes are polarized, so make sure to identify the polarity band (which indicates the "cathode", or negative side) and match the band to the footprint on the PCB.

For LEDs, the flat edge indicates the cathode. Line this up with the PCB footprint on the top side of the PCB and solder them flush with the PCB. (These LEDs are used as clipping diodes. The indicator LED will be done in a later step.)

# SOCKETS & ICS

PART	VALUE
IC1	OP07

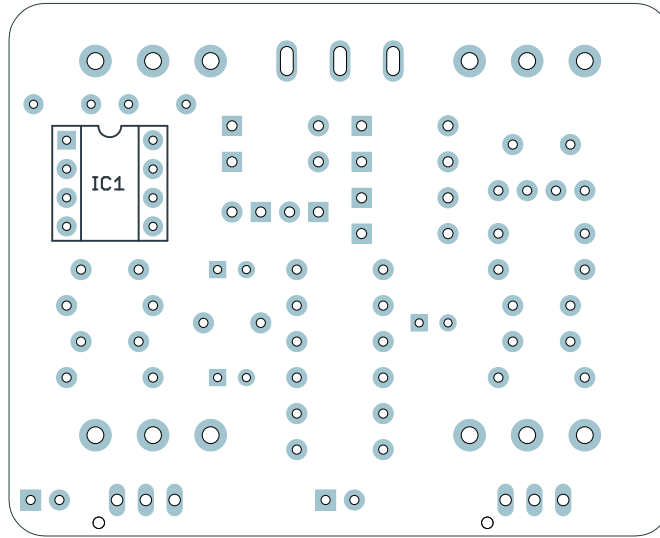

Next up is the IC socket. You can't bend the leads of the sockets like you can with the other components, so they won't stay in on their own until they are soldered.

Again, it's much easier to do all of these at once with gravity holding them in place for you, so you'll want to do them before you do any of the taller components.

## Installing the IC

Don't insert the IC into the sockets just yet. We will do this in a later step, after we've finished soldering the tallest components (the polarized capacitors). This information is just listed here for reference.

The legs of an IC are bent outward slightly during manufacturing, so they'll need to be bent back inward before they can be inserted into the sockets.

It's easiest to do this by laying the IC legs against the table and bending the body itself so all four legs on the side are straightened out at once. Then, flip it and do the other side.

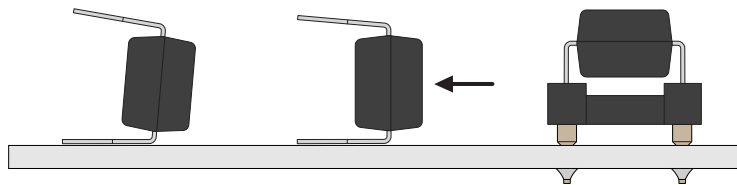

ICs may have two different orientation marks: either a dot in the upper-left or a half-circle notch in the middle of the top side. Some ICs have both marks. This shows which way the IC should be rotated when inserting it into a socket (the socket also has a half-circle notch).

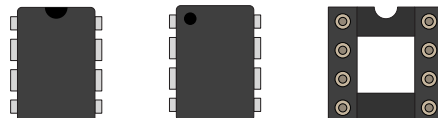

# TRANSISTORS

PART	VALUE
Q1	PN4303

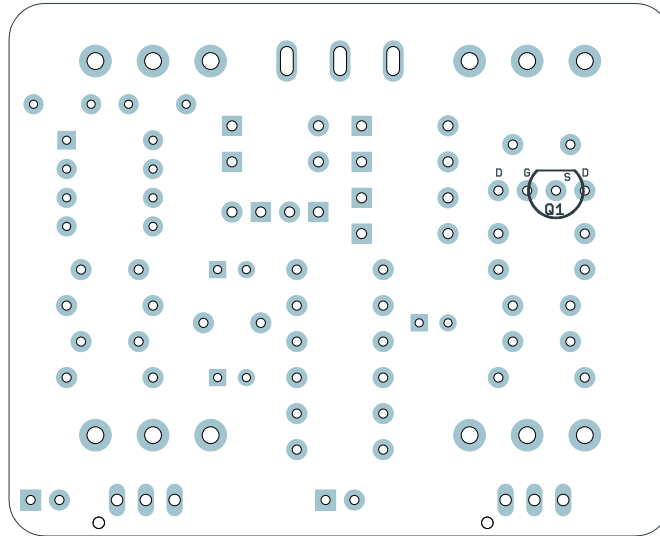

Now we'll do the JFET transistor. If the legs are not already bent into 0.1" spacing, use your needle-nose pliers to bend the outer two legs as shown.

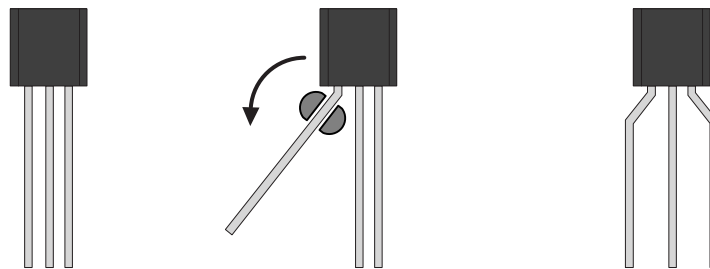

Since this is just used as a simple gain recovery stage, the JFET doesn't need to be audited for any particular characteristics, so sockets are not necessary. You can just solder them directly to the board.

Bend the outer leads to hold it in place on the board. Then, solder them and clip the leads.

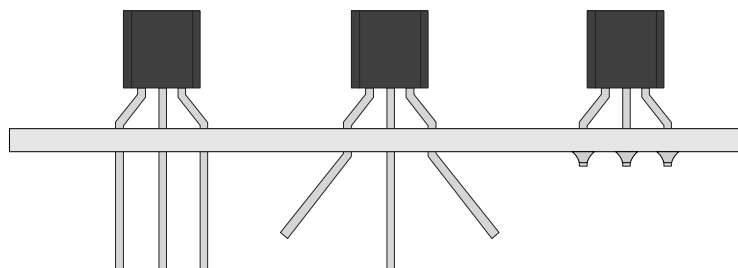

## CAPACITORS (NON-POLARIZED)

PART	VALUE	PART	VALUE
C1	22n (0.022)	C9	22n (0.022)
C2	1n	C10	1uF
C4	100pF MLCC	C11	100n MLCC
C8	3n3		

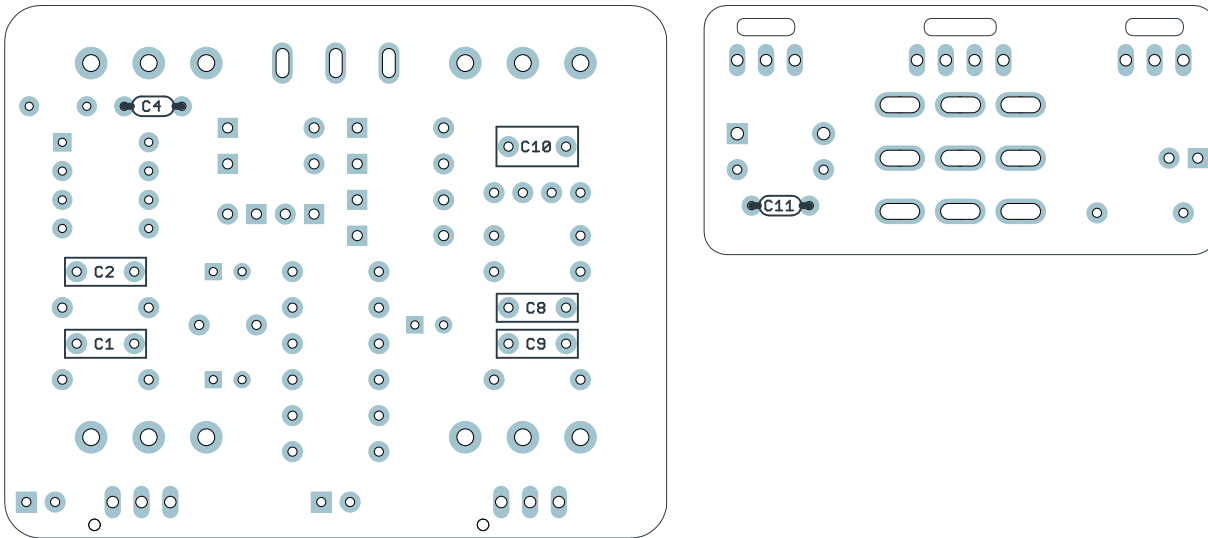

After the sockets come the box film and MLCC capacitors. These are all several different heights, but there aren't as many, so just do them all at once. Bend the leads at an angle to hold them in place.

MLCCs and box capacitors are not polarized and will work in any direction. To keep things neat, though, it's best to put them all facing the same way.

**Note:** C3 and CX1 are not used in this kit and will be left empty on the board.

Depending on the type, the box film capacitors may have their value printed on either the top or the side. Usually the red ones have it printed on the side while the blue or gray ones have it on the top.

The 100pF MLCC is blue and taped to cardboard. C11 (100n MLCC) is always yellow.

## WIRE HEADERS

---

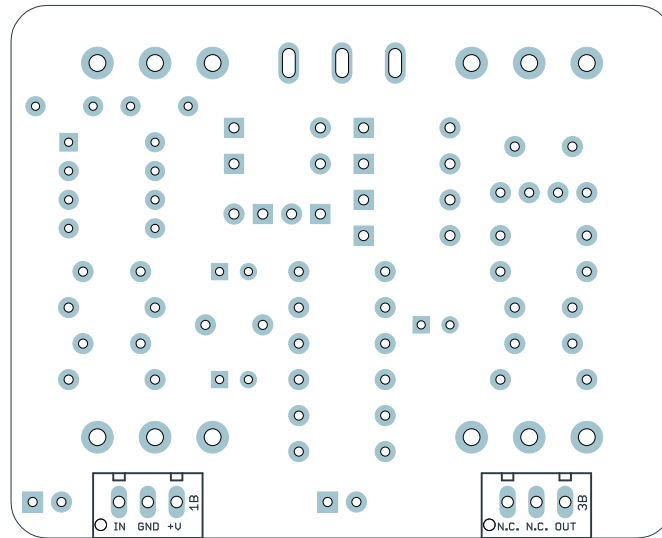

Install the two 3-pin headers (wire connectors) as shown above. These have a polarity pin, so as long as they are pressed all the way down, there's only one possible way to install them. They do fit pretty tightly in the holes, though, so press firmly.

There's also a 4-pin header on the I/O board that we will do in a later step.





# FOOTSWITCH PCB

## PARTS

3-strand wire assembly (2)

4-strand wire assembly

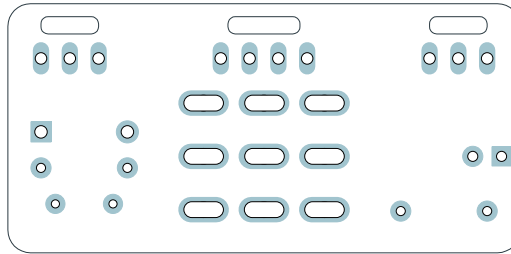

Next, it's time to finish up the footswitch board. You should have done most of the on-board components on this board in a previous step, but if not, go back and do those.

There will be one longer assembly with 4 wires and two shorter ones with 3 wires. The longer one goes in the middle and the shorter ones go on the left and right sides. The wire assemblies should then be soldered to the footswitch board as shown.

### STEP 1

First, thread the wire through the strain-relief slots, with the blue side facing outward and the PCB silkscreen facing up.

For now, pull it through as far as it can go.

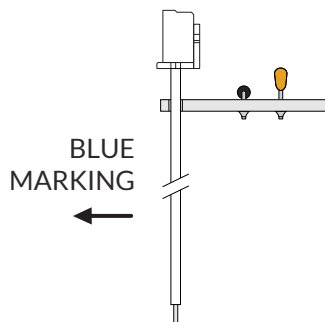

### STEP 2

Next, bend the wires back upward and fit the ends of the wires into the solder pads.

On the top side of the PCB, bend the exposed wires backward so it holds the wire in place. Pull the header back up through the slot partway.

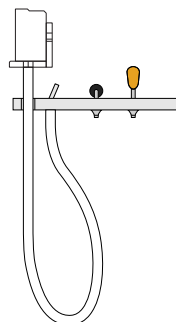

### STEP 3

Then, solder the wires from the top. This is the trickiest part of the whole build. You want to solder the pads without touching the iron to the wires themselves and risking burning through the insulation. It helps to use a sharp or narrow tip on the soldering iron.

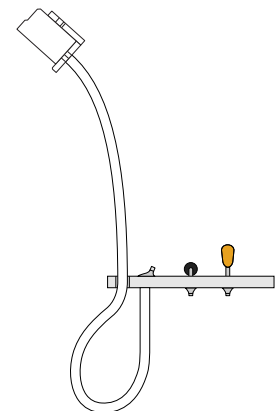

Once all three wire assemblies are soldered, set the footswitch PCB aside. We'll solder the actual footswitch and LED in a later step.

# INPUT/OUTPUT PCB

## PARTS

Input & output jacks

DC jack

Wire header

9V battery snap

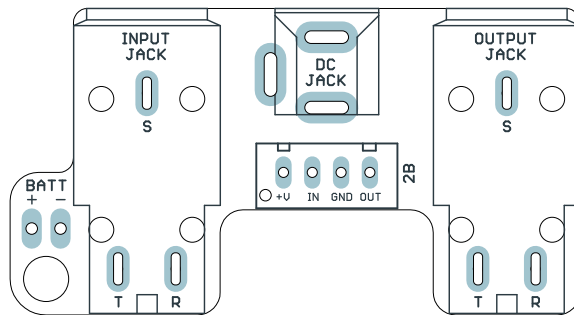

Almost done! Get the two input/output jacks, the DC jack and the wire header and snap them in place. The PCB is designed for them to fit securely, so you can do them all at once before flipping and soldering.

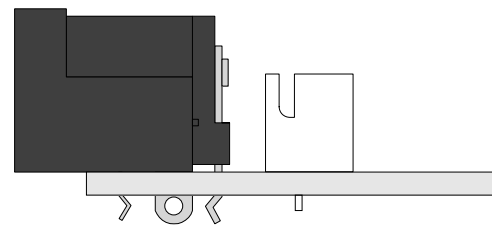
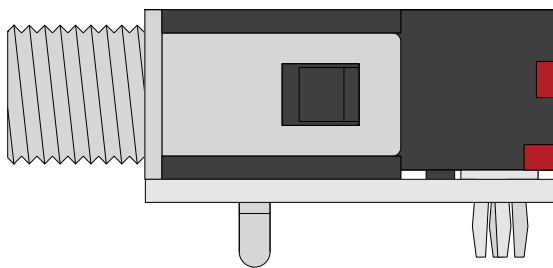

After you've soldered everything, make sure to **snip the leads on the I/O jacks as close as possible to the PCB**. There's not a lot of clearance between the bottom of this board and the top of the main PCB once everything is in place, and you don't want the pins to short against anything on accident.

Next, we'll hook up the 9V battery connector. **This is optional.** Not everyone uses batteries. But, if you do, this pedal should last a long time on a single 9V so you won't need to change it very often.

## STEP 1

Thread the battery snap leads through the strain-relief hole twice so it forms a single loop.

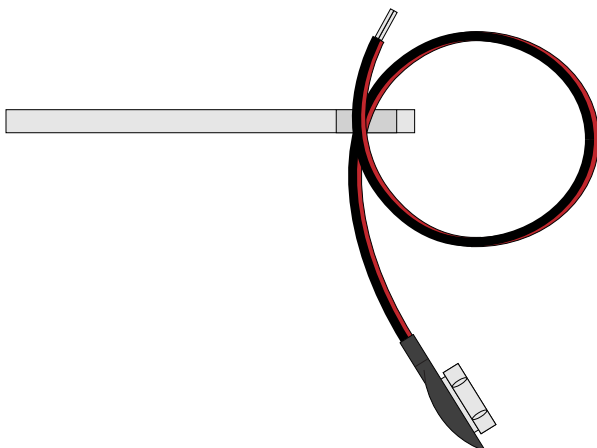

## STEP 2

Bend the exposed wires back down and solder them into the pads. Red is positive (+), black is negative (-). After soldering, pull it tight.

For even more strain relief, you can thread the snap through the loop to form a knot. (not shown)

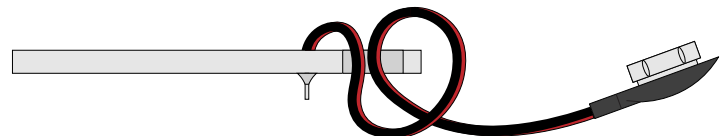

# ENCLOSURE LAYOUT: PANEL MOUNTS

Attach the hardware to the enclosure as shown. (The I/O board is done in a later step.)

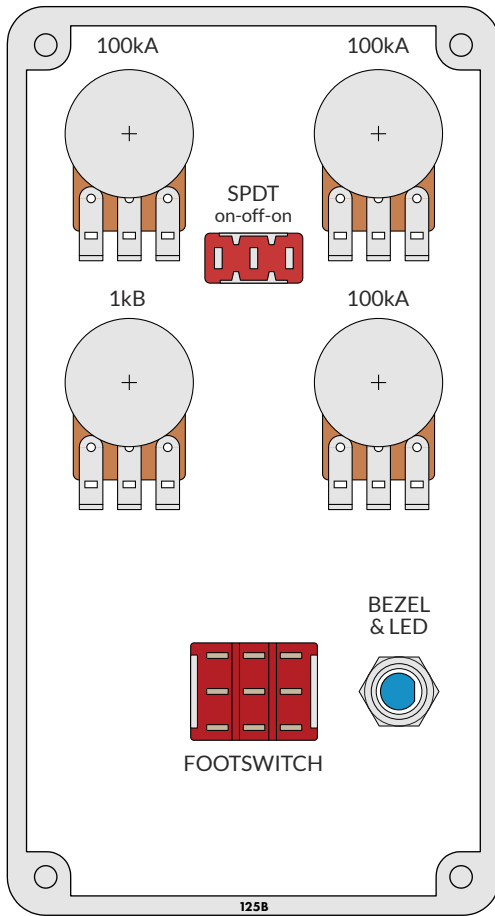

## FOOTSWITCH

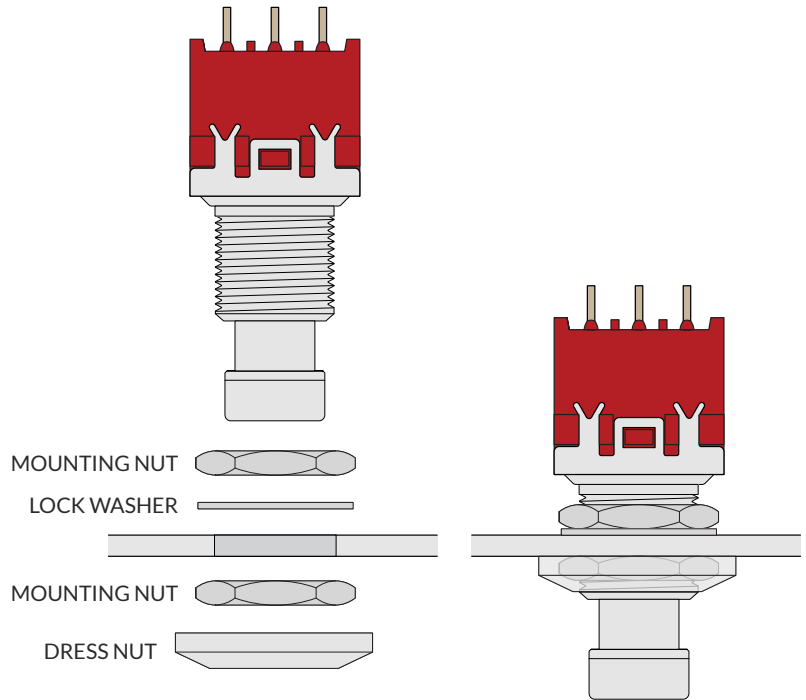

The dress nut fits over the top of the mounting nut and is for aesthetic purposes only. Wrap a rubber band around it to use as a grip when tightening. Do not use metal tools on it or you run the risk of scratching or denting it.

## POTENTIOMETERS

Level: 100kA

Distortion: 100kA

Filter: 100kA

Sweep: 1kB

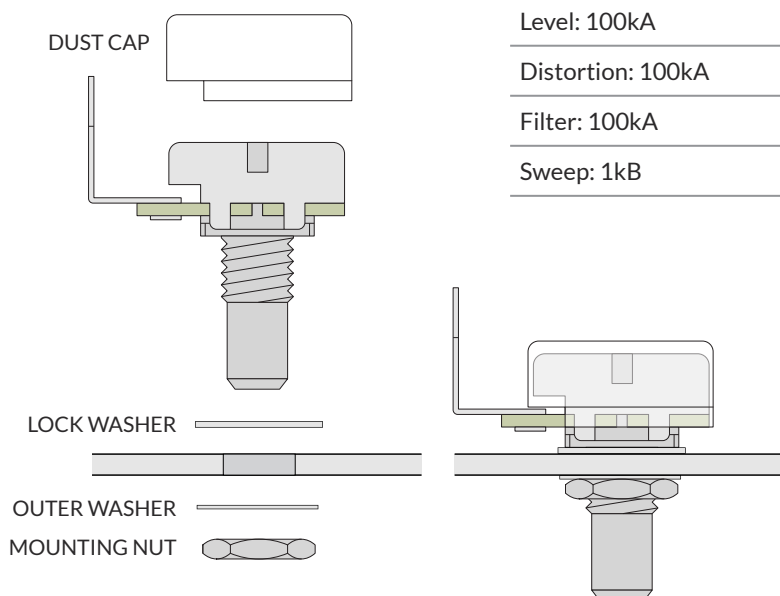

## BEZEL & LED

The LED will just sit loosely inside the bezel for now.

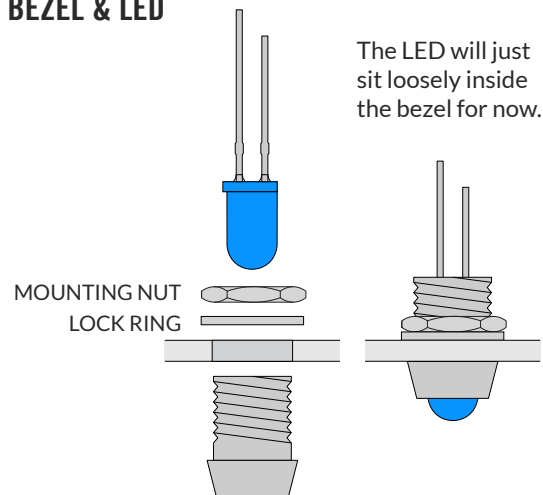

You'll need to hold the bezel in place when tightening the nut. The top of the bezel is fairly sharp, so try using a rubber band for grip instead of pressing your finger against it.

# ENCLOSURE LAYOUT: PANEL MOUNTS (CONT.)

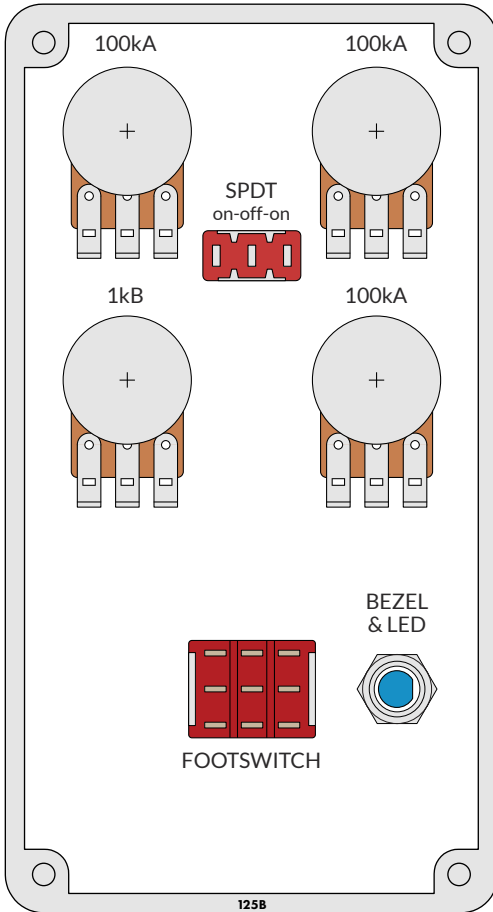

## TOGGLE SWITCHES

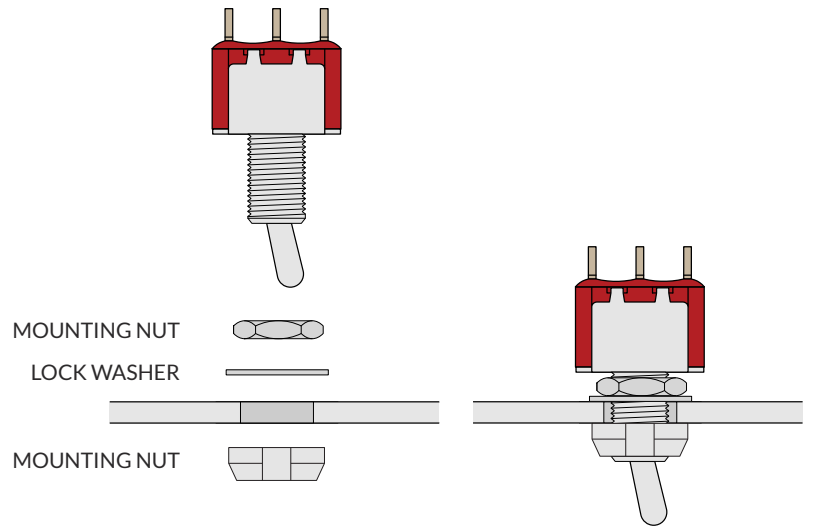

The dress nut acts as a mounting nut, unlike the footswitch dress nut. Use flat-nose pliers on the flat sides of the nut to tighten securely.

## ENCLOSURE LAYOUT: MAIN & FOOTSWITCH PCBs

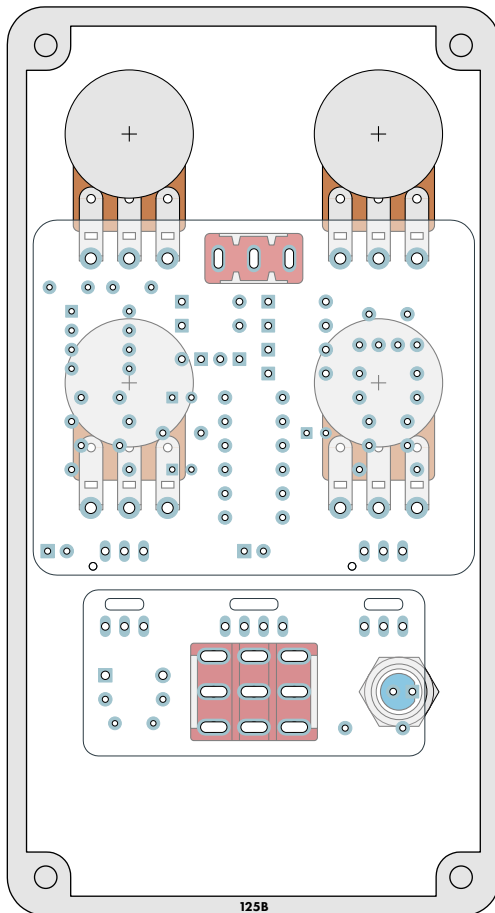

After all the components are affixed to the enclosure as shown on the previous page, place the main PCB on top of the potentiometers and toggle switches as in the diagram to the left.

You may need to adjust the position of the potentiometers and toggles slightly if they are not aligned straight.

Once all of the pins are through their holes and the PCB is laying flat, solder each of the pins from the top. Be careful not to touch any of the surrounding components with the soldering iron.

After you've finished soldering the pots, **clip the leads as close as you can to the main PCB**. This is more important with the two uppermost pots because the input/output PCB overlaps them and you need to avoid any of the components shorting. (The toggle switch lugs do not need to be clipped.)

Next, move to the footswitch board and solder the 3PDT switch.

The LED is last. Before soldering the LED, double-check to **make sure the flat side of the LED is facing to the right**, as shown in the diagram, and that the short leg is coming through the pad on the right. It won't work if it's turned the other way. Then, clip the leads of the LED.

### Why solder everything inside the enclosure before testing it?

“Rock it before you box it” is conventional wisdom in pedalbuilding, and you'll often hear it recommended that builders should test the circuit before putting everything inside the enclosure. However, Aion FX projects are designed to be extremely easy to remove from the enclosure for troubleshooting, with no desoldering required—so with these kits, it's actually much easier to “box it before you rock it”.

If you've read the documentation carefully and followed all the instructions, there's a good chance you will get it right the first time!

# ENCLOSURE LAYOUT: INPUT/OUTPUT PCB

Affix the input/output PCB to the north-facing panel of the enclosure as shown.

Note the use of two mounting nuts on each of the jacks, one inside and one outside. The inner nut acts as a spacer to set the DC jack flush with the outside of the enclosure. The inner nuts should be threaded as far down as they can go.

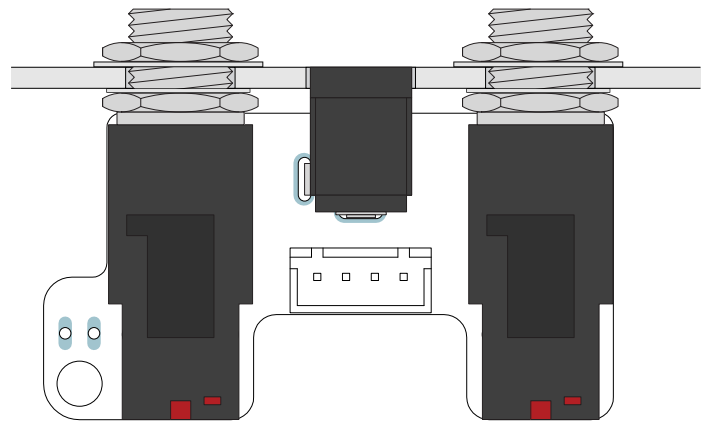
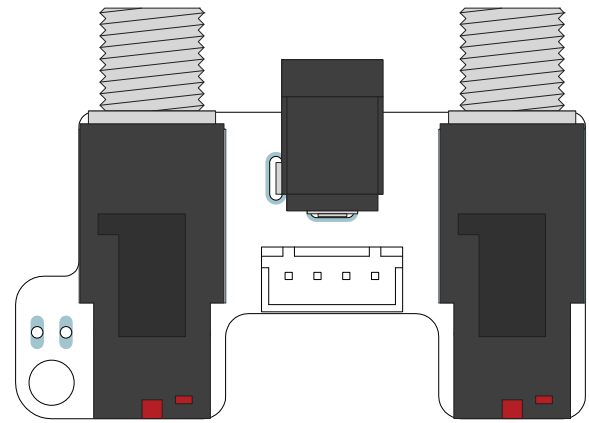
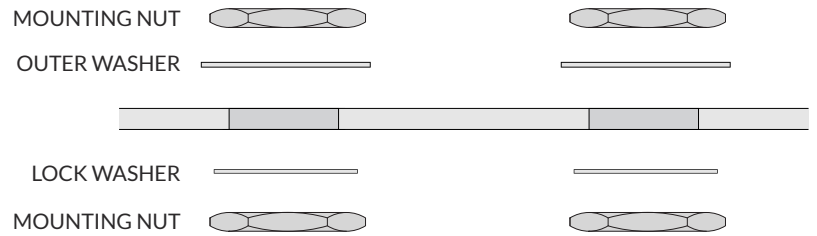
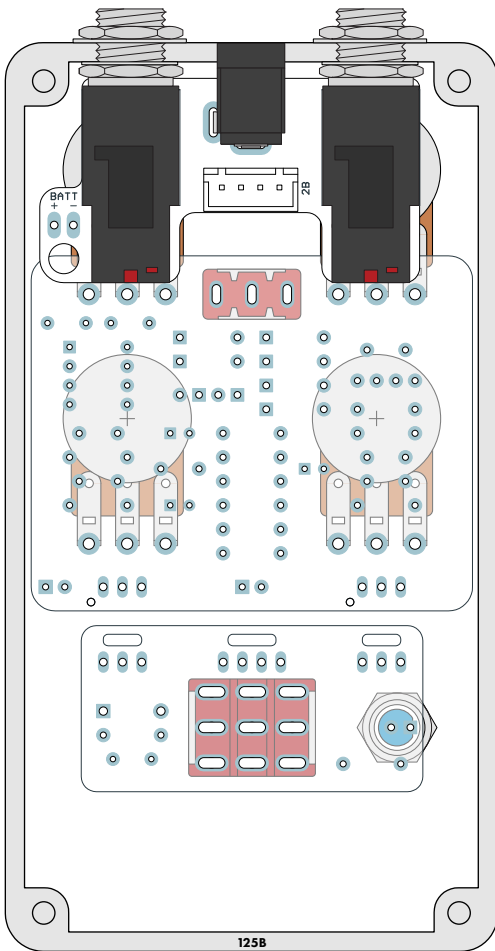

## FINAL TESTING & ASSEMBLY

After everything is in place, plug the 3 wire assemblies into their respective headers and make sure they're secure. Here is a cross-section of the inside of the completed pedal.

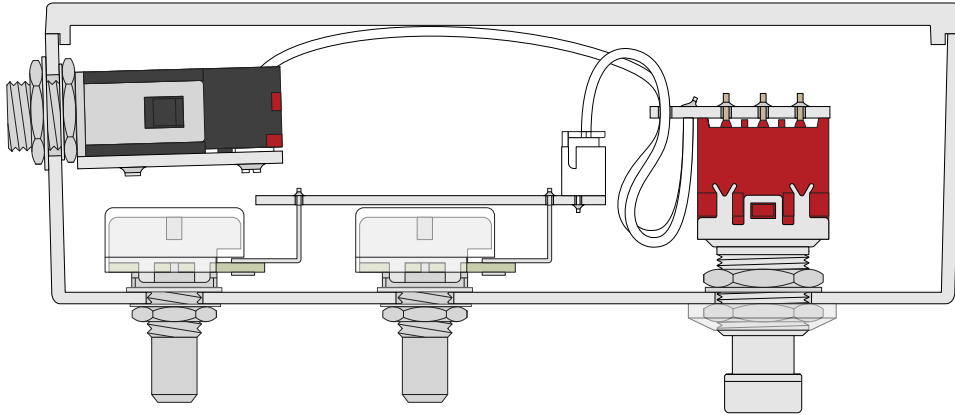

At this point, you have completed the full circuit as far as the electrons are concerned. Plug in a 9-volt supply and test it out with a guitar and an amplifier.

Test the bypass switch a few times, then start turning the knobs and see if everything sounds OK. If it works, great! If not, don't be discouraged. See page 26 for troubleshooting info.

### Finishing touches

Now, just a couple of things for the final assembly. Turn the shafts all fully counter-clockwise, then put on the knob and rotate until the indicator line is aligned with the dot on the enclosure that shows the zero point. Affix the knobs to each of the potentiometer shafts as shown in the diagram below.

Using a small flat-head screwdriver (no more than 0.1" / 2.5mm in diameter), firmly tighten the set screw until it presses against the shaft of the potentiometer and holds the knob in place.

Be careful not to over-tighten or you may damage the set screw. But if it's not tight enough, the knob will be more likely to fall off or lose its alignment with the markings on the enclosure.

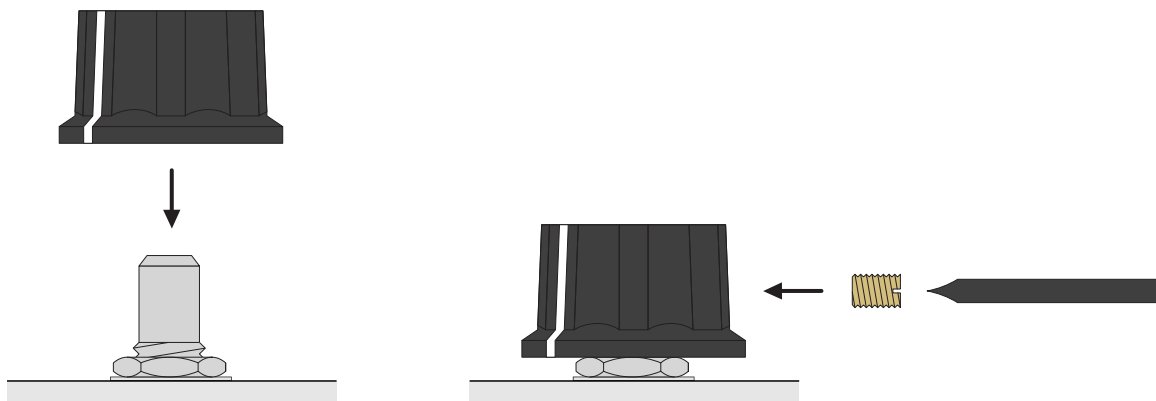

Last, just close the panel on the back using the four screws. That's it!

# SCHEMATIC

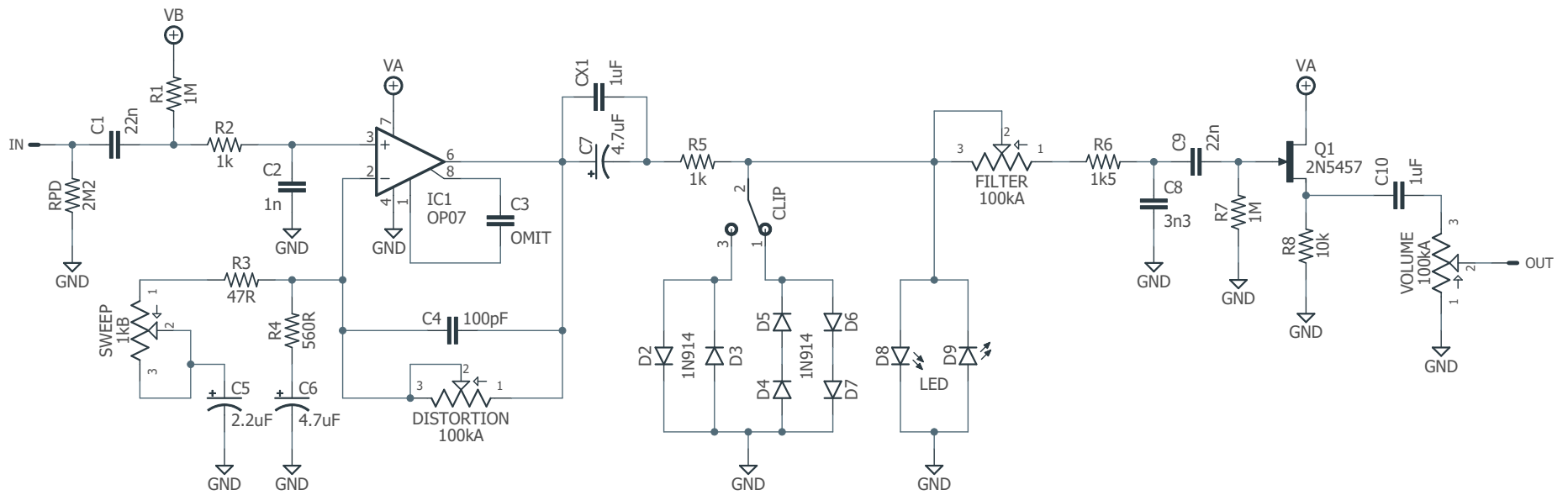
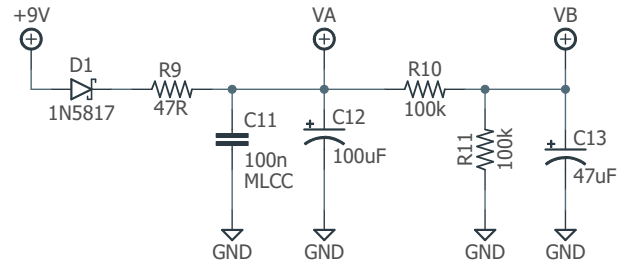



# FULL PARTS LIST

---

## Resistors

PART	VALUE
R1	1M
R2	1k
R3	47R
R4	560R
R5	1k

PART	VALUE
R6	1k5
R7	1M
R8	10k
R9	47R
R10	100k

PART	VALUE
R11	100k
RPD	2M2
LEDR	10k

## Capacitors

PART	VALUE
C1	22n (0.022)
C2	1n (0.001)
C4	100pF (101)
C5	2.2uF
C6	4.7uF electro
C7	4.7uF electro
C8	3n3 (0.0033)

PART	VALUE
C9	22n (0.022)
C10	1uF
C11	100n MLCC
C12	100uF electro
C13	47uF electro

## Diodes

PART	VALUE
D1	1N5817
D2	1N914
D3	1N914
D4	1N914
D5	1N914

PART	VALUE
D6	1N914
D7	1N914
D8	3mm LED
D9	3mm LED

## Transistors

PART	VALUE
Q1	PN4303

## ICs

PART	VALUE
IC1	OP07

## Potentiometers

PART	VALUE
Volume	100kA
Drive	100kA
Tone	100kA
Sweep	1kB

## Switches

PART
SPDT on-off-on
3PDT stomp

# TROUBLESHOOTING INFORMATION

---

If you finish building the kit and find that it doesn't work right, we've written a separate in-depth [Troubleshooting Guide](#) that applies to all of our kits. The main troubleshooting process is covered there. Here you will find information specific to this kit that will help with that process.

## Voltages

The following voltages are taken from our prototype unit using a **9.60V** supply. Your measured voltages won't be exactly the same due to variance in power supplies and component tolerances. However, if you see anything more than +/-0.5V from the listed voltages, it's a good indicator of an issue, and the exact voltages can help narrow it down.

Note that IC pins are labeled counter-clockwise from the upper-left, as shown in the diagram to the right. For JFETs, the legs will be marked on the PCB.

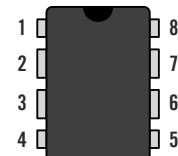

### IC1

PIN	VOLTAGE
1	9.29
2	4.68
3	4.25
4	0
5	<i>no connection</i>
6	4.68
7	9.39
8	9.29

### Q1

PIN	VOLTAGE
D	9.35
S	1.65
G	0

## SUPPORT

---

**Aion FX does not offer direct support for these projects beyond the provided documentation.**

Replacements and refunds cannot be offered unless it can be shown that the circuit or documentation are in error or that the included components are non-functional.

### Where to get help

The three best places to ask for help are the [DIY Stompboxes forum](#), the [DIY Stompboxes Facebook group](#), and the [r/diypedals subreddit](#). These communities have more than 150,000 members between them and they are very accommodating to new builders.

When posting a troubleshooting request, always include the following:

1. A thorough description of the problem you are experiencing
2. A photo of the inside of the pedal
3. A list of all the measured voltages of each of the pins, described on the previous page

While we cannot offer direct, private support, you may send a link to your public troubleshooting thread to Aion FX using the contact form on the website. There is no guarantee that we will be able to join the discussion and help solve your problem, but this improves the chances.

It benefits the whole community if the troubleshooting process is public because then people who have the same issue in the future may come across it when searching. And if you do get help, remember to pay it forward! The best way to learn new skills is to help others. Even if you've only built one pedal, you have more experience than someone who is brand new, so you have something to offer.

## RESALE TERMS

---

These kits may be used for commercial endeavors in any quantity unless otherwise noted. It's okay to sell individual builds locally or online, or even to offer a service to build pedals based on these kits.

No direct attribution is necessary, though a link back is always greatly appreciated. The only usage restriction is that you cannot "goop" the PCB or otherwise obscure the source. In other words: you don't have to go out of your way to advertise the fact that you use Aion FX kits, but please don't go out of your way to hide it. The guitar effects industry needs more transparency, not less!

## LEGAL INFORMATION

---

Pro Co® is a registered trademark of Pro Co Sound, Inc.

All other trademarks are property of their respective owners.

Any use of trademarks is for comparative advertising purposes only under fair use. It is not an endorsement of this product by the trademark holders.

These kits are intended to be built by the customer. Aion FX is not responsible for language that may be used by the customer in the marketing or resale of the finished product.

All content and graphics in this document are original works and are copyrighted by Aion FX and may not be used without permission.

## DOCUMENT REVISIONS

---

### 1.0.1 (2024-08-08)

- Updated LEDR (LED current-limiting resistor) to 10k to reduce brightness.
- Added link to troubleshooting guide on page 26.

### 1.0.0 (2019-07-04)

Initial release.